

INTERFER

ITALIANA
ferramenta

FLIPPER

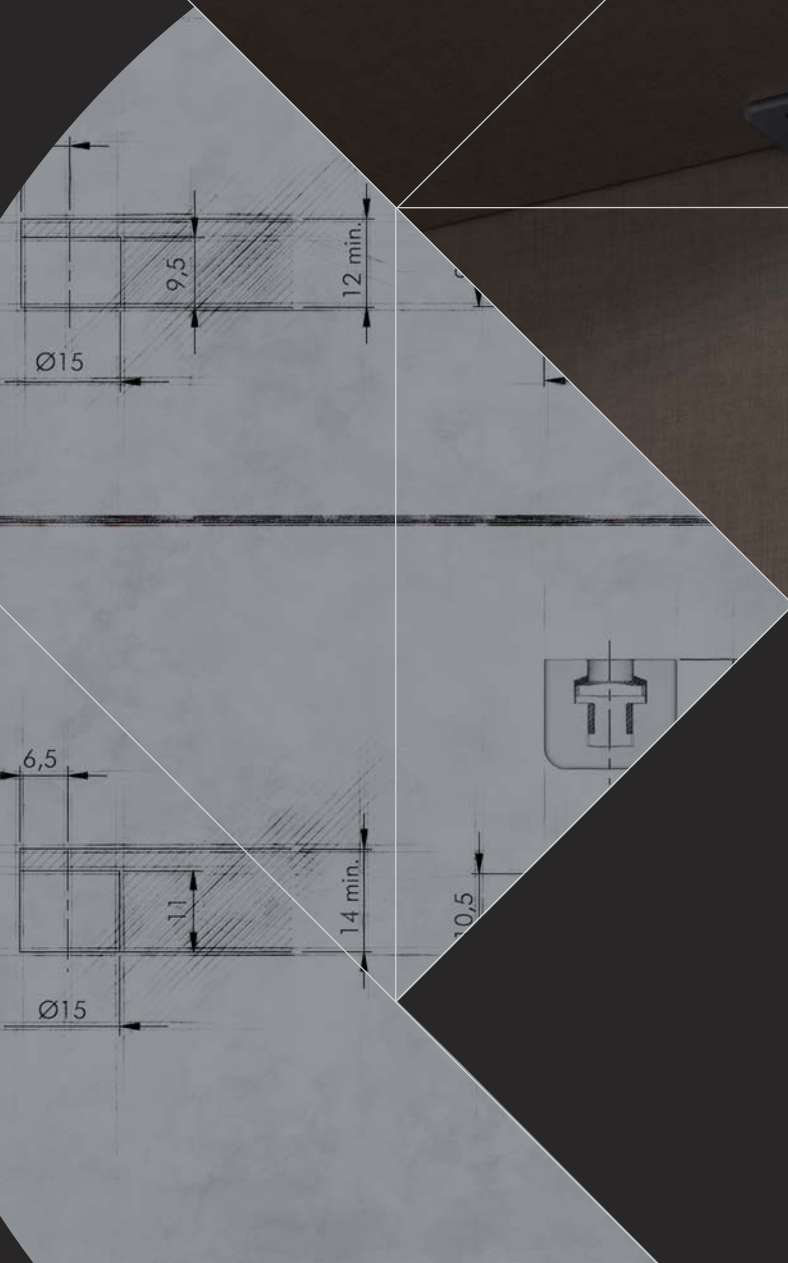

**SHELF
SUPPORTS**



FLIPPER



FLIPPER is a wood shelf support slotted into the shelf by making face borings.
 The shelf has to be pushed downwards onto the side dowels, which can be placed or screwed into any required position.
 The side dowels slot into the socket of the shelf supports and a click locks the shelf in position.
 To provide a structural fastening to the furniture, screwed side dowels are required, so that the shelf flushes with the sides, due to the angled shape of the shelf support sockets.



12 mm min.

s available on request.

INSTALLATION

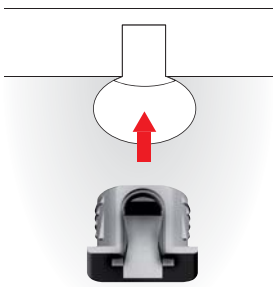

Assembling with smooth pin

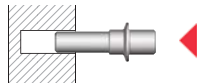

Assembling with threaded pin to achieve horizontal connection

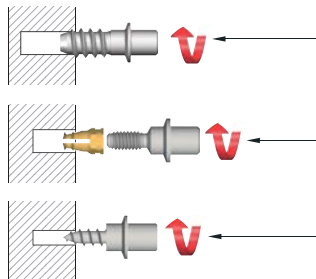

cross PZ2 screwdriver



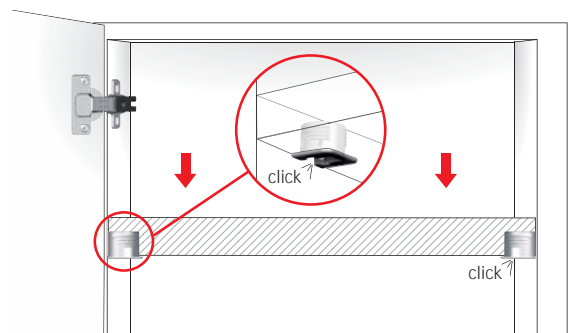
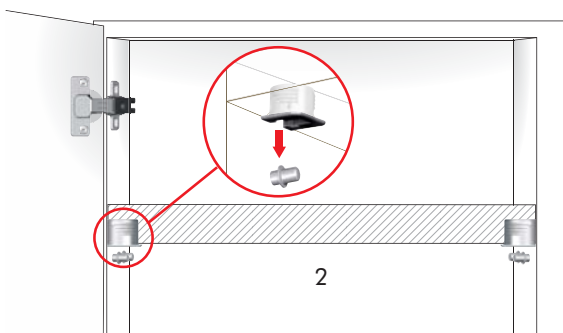
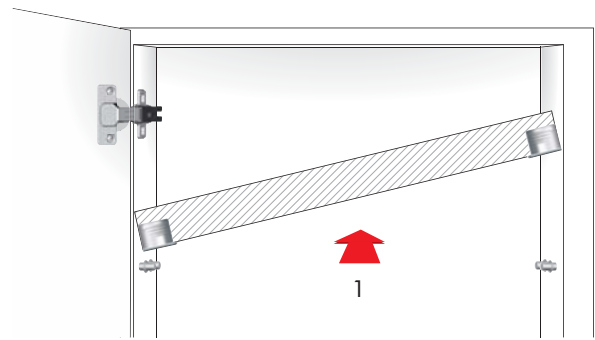

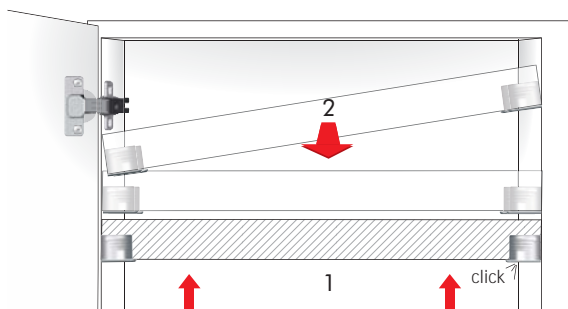

SHELF INSTALLATION

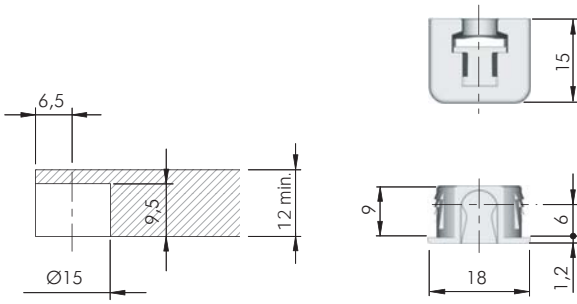







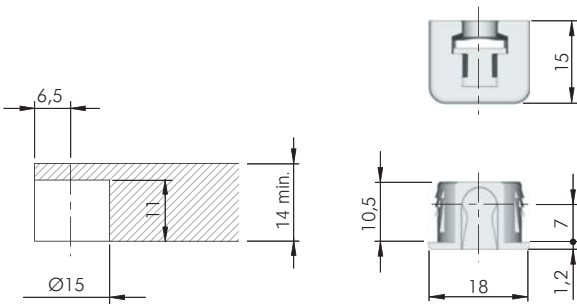

SHELF REMOVAL FOR NEW REPOSITIONING











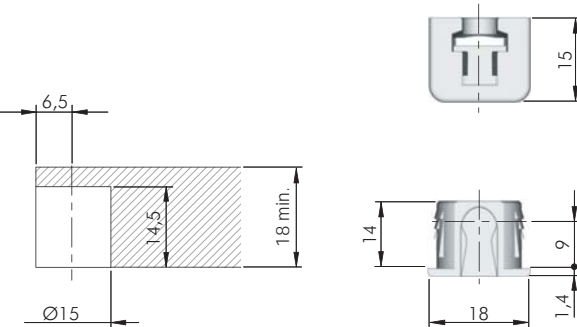

 = 12 mm + 
  = 10.000 pcs.
  
10601010AB | **JG**







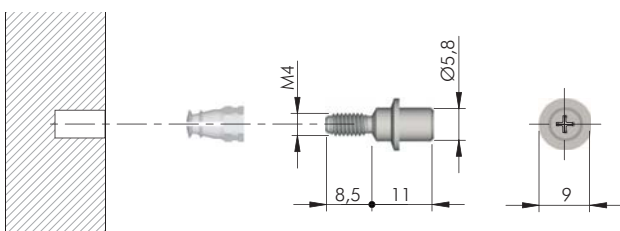

 = 14 mm + 
  = 10.000 pcs.
  
10601021AB | **JG**



 = 18 mm + 
  = 2.500 pcs.
  
10601030AB | **JG**



 = M4
 = PZ2
  = 2.500 pcs.
 
10602010ZN

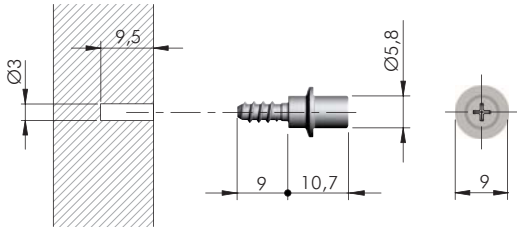

= $\varnothing 3$ mm

= PZ2

ST

= 2.500 pcs.



10603031ZN

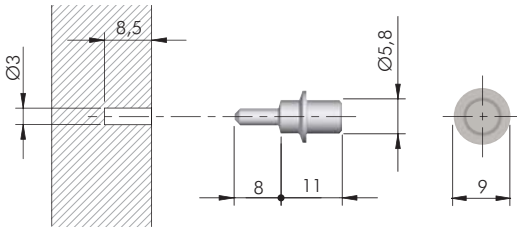

= $\varnothing 3$ mm

ST

= 5.000 pcs.



10605030ZN

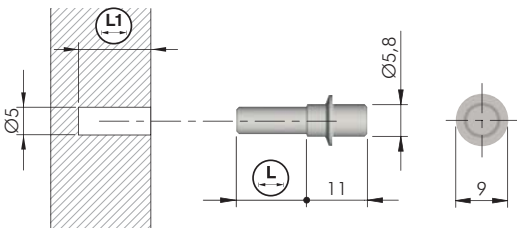

= $\varnothing 5$ mm

ST

= 2.500 pcs.



10605020ZN



12,5



13

10605010ZN

8,5

9

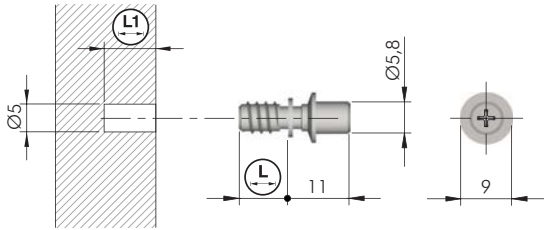

10604020Z^N



7,5



8



2.500

10604010Z^N

8,8

9,3

2.500

FLIPPER FIXING ACCESSORY

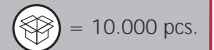
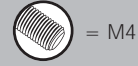
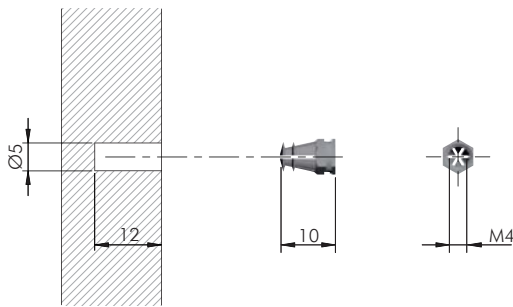

20502021H^L

DRILL BIT FOR FLIPPER 12, 14, 18 mm

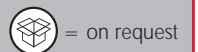
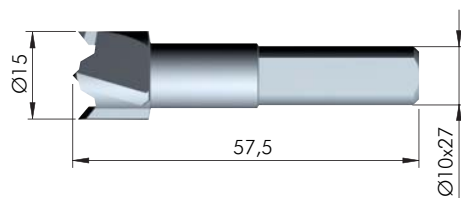
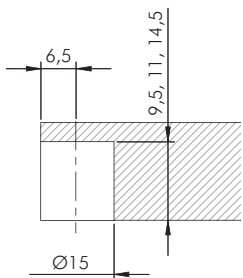

1065201000

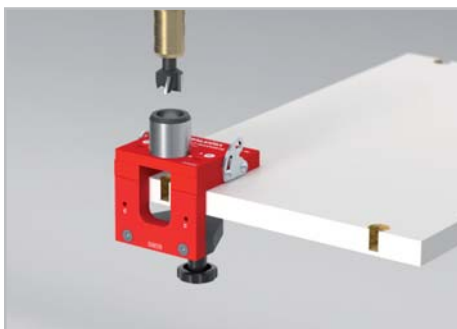

All the information about drilling jigs are available at the end of the chapter "Shelf Supports".



SYMBOLS AND FIN INTERFER

SYMBOLS

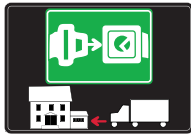

= SHELF SAFELY LOCKED DURING TRANSPORTATION AND AT HOME.



= ANTI-TURNOVER LOCKING SYSTEM



= NORMS / PATENTS



= PHILLIPS / POZIDRIV



= WITH BUFFER



= PART NO.



= BLADE SLOT



= WITH MAGNET



= PCS. PER PACKAGE



= COMBI SLOT



= HEXAGONAL SOCKET



= NEWTON



= CAPACITY LOADING



= HEXALOBULAR SOCKET



= FRICTION



= WOOD / GLASS THICKNESS



= COUNTERSUNK HEAD



= AUTOMATIC



= HOLE DIAMETER



= PAN HEAD



= DROP DOWN



= DIAMETER



= FLANGE HEAD



= LENGTH



= FLAT HEAD



= STANDARD HINGE



= HEIGHT



= TRILOBULAR SCREW



= KIMANA HINGE



= RIGHT VERSION



= SELF-TAPPING SCREW



= FLAP HINGE



= LEFT VERSION



= EURO THREAD



= WITH SPRING



= SETTING CODE



= METRIC THREAD



= WITHOUT SPRING



= PCS. PER PAD



= PRE-INSERTED SCREW



= REVERSED SPRING



= CUT ON REQUEST



= PRE-INSERTED SCREW AND SPREADING BUSH



= SELF ADHESIVE



= WITH FLANGE

NOTE: Printing errors and omissions may exist despite our best efforts to ensure accuracy. We reserve the right to alter specifications without notice.

MATERIALS

ZA = Zinc Alloy	ST = Steel	HSS = High Speed Steel	BR = Brass	ABS = Acrylonitrile Butadiene Styrene
ZAnk = Nickel-plated Zinc Alloy	STzk = Zinc-plated Steel	AL = Aluminium	WD = Wood	EVA = Ethylene Vinyl Acetate
EP = ENGINEERING PLASTIC			SR = SOFT RUBBER	
+ EP = other engineering plastic available on request			+ SR = other soft rubber available on request	

EPn = Natural Engineering Plastic	EPc = Clear Engineering Plastic	SRn = Natural Soft Rubber
EPw = White Engineering Plastic	EPg = Grey Engineering Plastic	SRw = White Soft Rubber
EPb = Black Engineering Plastic	EPa = Anthracite Engineering Plastic	SRb = Black Soft Rubber



FINISHES



= OTHER FINISHES AVAILABLE ON REQUEST

PART NO.	FINISHES	PART NO.	FINISHES	PART NO.	FINISHES
00	Insignificant finish	IF	Grey 7	XE	Inox
AA	Natural	IJ	Light Grey	YA	Nickel-plated
AB	White	IL	Grey 20	YC	Matt Nickel-plated
AE	White 9010	IN	Grey met. 26	YD	Satin-finished Nickel-plated
EA	Black	JG	Aluminium 5	YQ	Black Nickel
EC	Matt Black	JL	Aluminium PE 11	Z9	Black Zinc
EE	Anthracite	JM	Aluminium RAL 9006	ZN	Zinc-plated
EW	Grey 9007	KB	Bright Chrome	ZQ	Bright Gold
FU	Gunmetal	KC	Matt Chrome	ZZ	Clear/Transparent
FV	Gunmetal V52	LD	Brown 8019		
GR	Zamak Raw	RO	Red		
HA	Brass-Plated	UT	T-Met 9007		
HH	Tropicalized	UZ	T-Met		
HL	Raw Brass	WA	Bronzed		
HX	Graphite	WI	Burnished		
IA	Grey	XD	Satin-finished Steel		

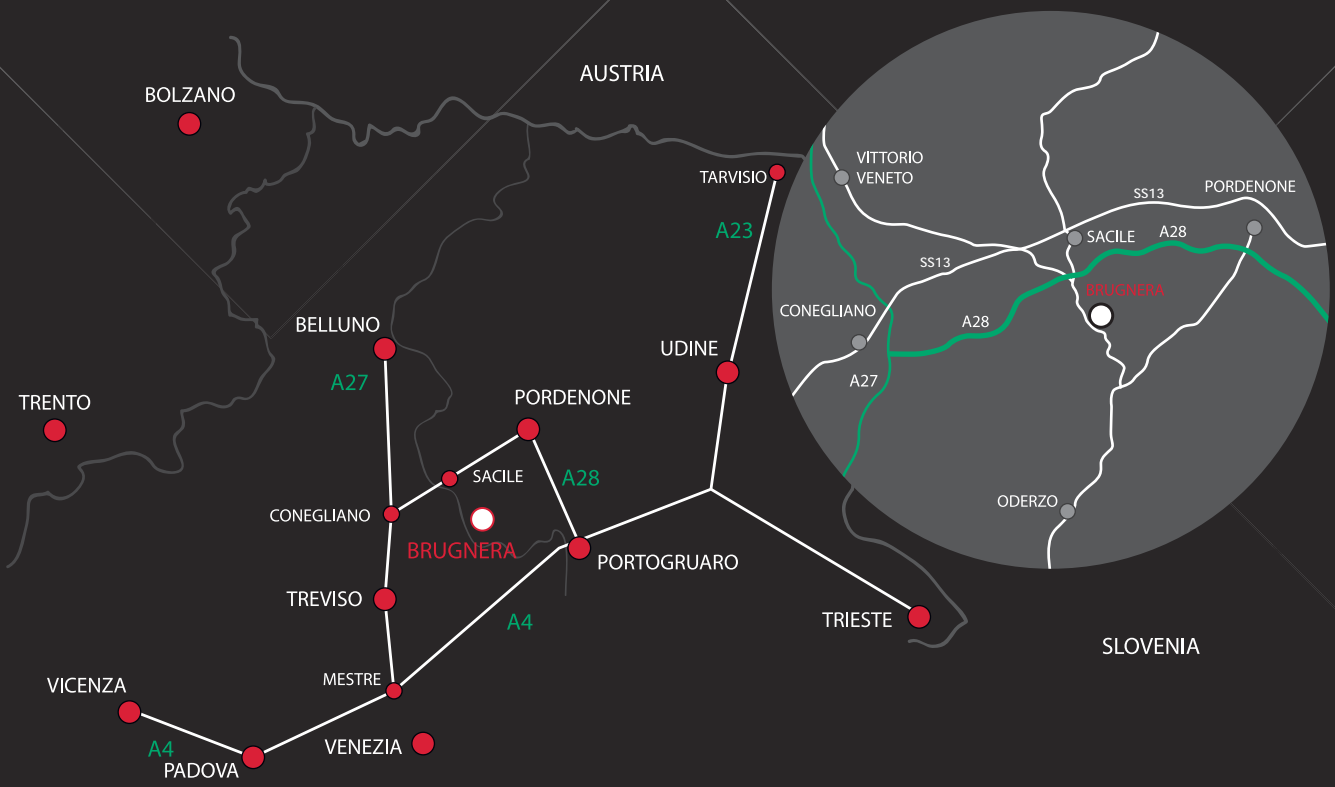

www.italianaferramenta.com