



**TopLine XL**



The last word in sliding perfection:  
Sliding door system TopLine XL

All the benefits at a glance

**INTERFER**

Technik für Möbel

**Hettich**

# Puristic design of large fronts



**Advanced technology, discreet look:**  
the running component is extremely shallow, making it hardly visible. The Silent System ist almost completely concealed behind the profile, leaving the spotlight on your wardrobe's design.

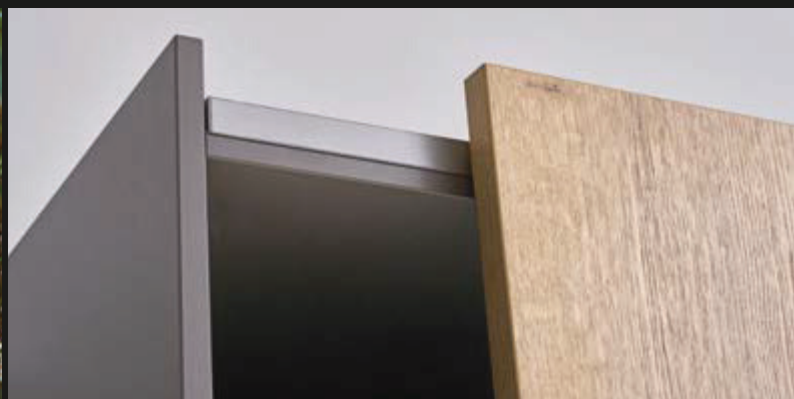

**Elegant look from clip-on installation:**  
ceiling height wardrobes without visible screws.

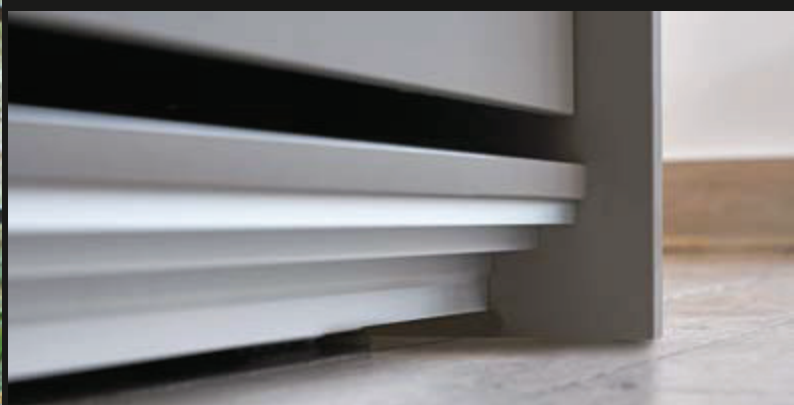

**Aesthetic appeal all round:**  
the bottom guide profile is set back beneath the base panel - almost hiding it from view.

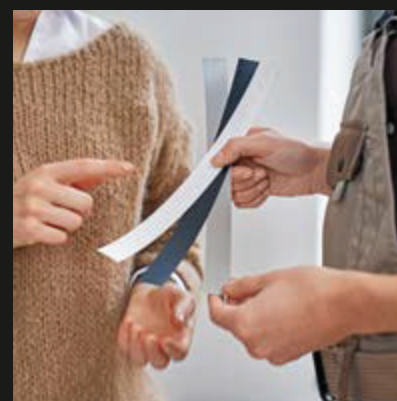

**Perfectly finished runner profile:**  
self-adhesive decorative tapes available in 3 classy colours - champagne, white and black - can be used to match the profile's visible surface to the wardrobe interior for a look of harmony.

Productvideo  
<https://www.hettich.com/short/8c6323>



Experience unequalled user convenience





**Impressive user convenience:**  
very low opening forces mean the doors are easily opened with a mere stroke of the hand. The new generation Silent System then slows the doors down particularly gently.

# Experience unequalled user convenience



**Practical convenience:**

the centre door can be opened to the right and left. On closing, it is gently slowed down from either direction and silently pulled into the end position.

TopLine XL in motion  
<https://www.hettich.com/short/e011b0>



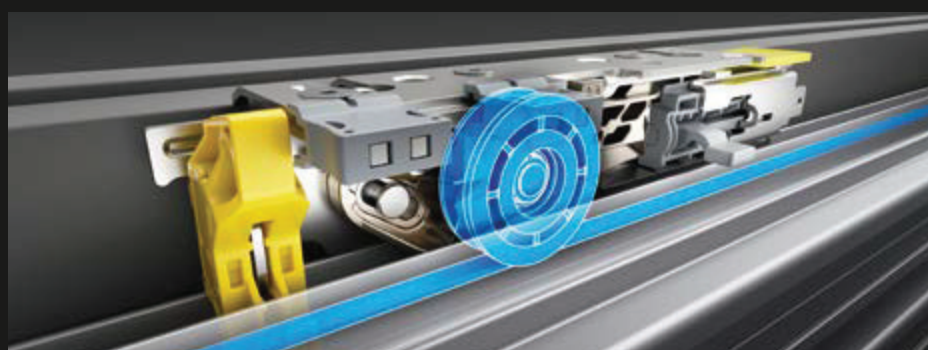

**Smooth, quiet running action:**  
the rollers continue to move in virtual  
silence even after prolonged periods out  
of use.



Install doors easily and securely



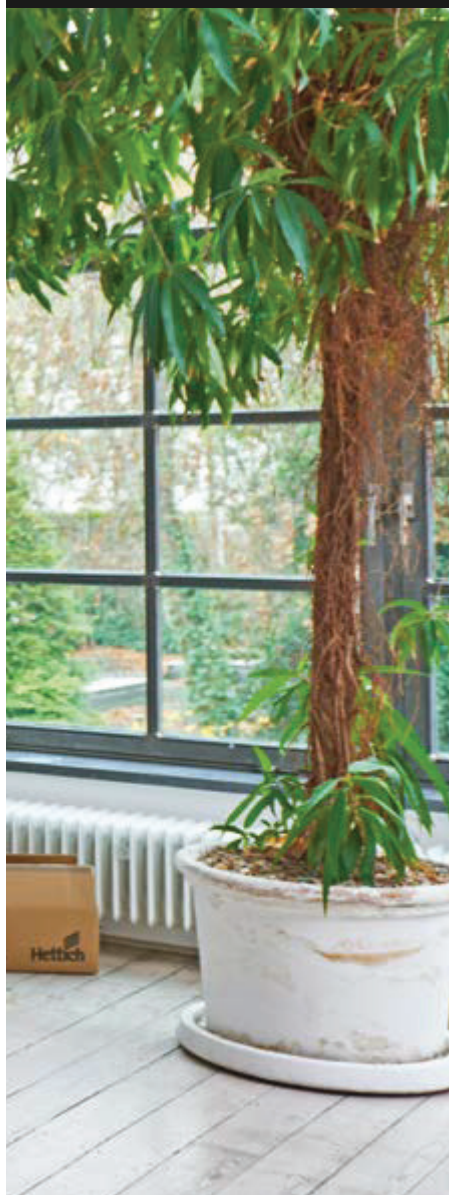

**Silent System installation made easy:**

calculating the position of the Silent System with complicated formulae and accurately measuring everything out - that was yesterday. The Silent System elements simply screw into the end cap - job done!!

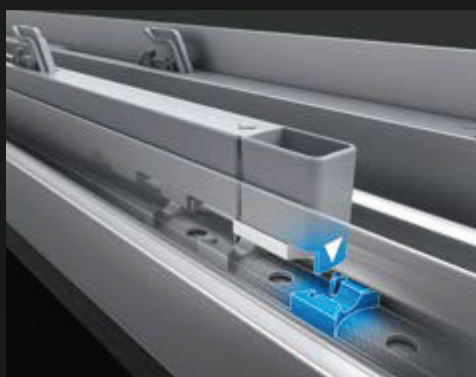

**Correct installation guaranteed:**

the Silent System element can only be fitted in the end cap in the correct position. This reliably prevents any malfunctioning and damage to the system.

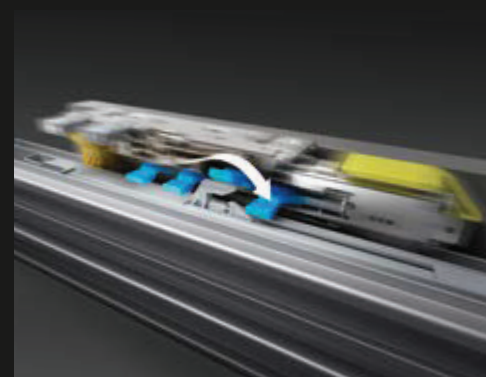

**Incorrect installation ruled out:**

there is no need to activate the Silent System. After closing a door for the first time, Silent System automatically works correctly. Even if the door is installed on the wrong side of the Silent system element.

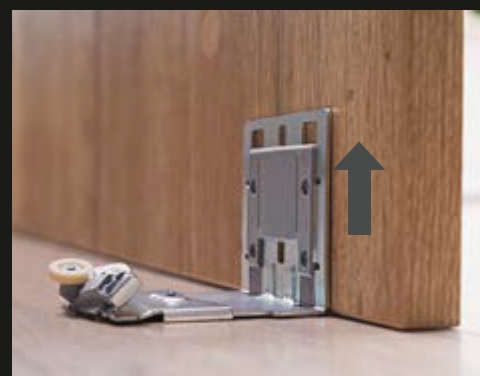
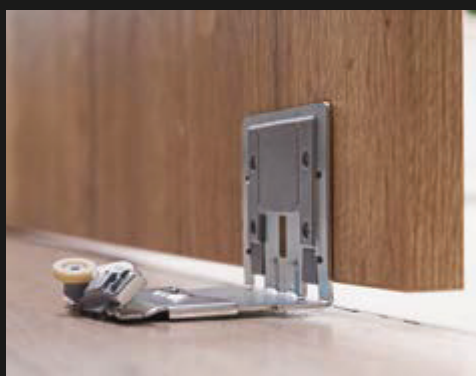

**Innovative floor standing guard:**

before fitting them, the doors can be set down on the floor without having to worry about damaging them. The bottom guide components then glide up automatically.

# Install doors easily and securely



Assembly animation  
<https://www.hettich.com/short/8bd317>



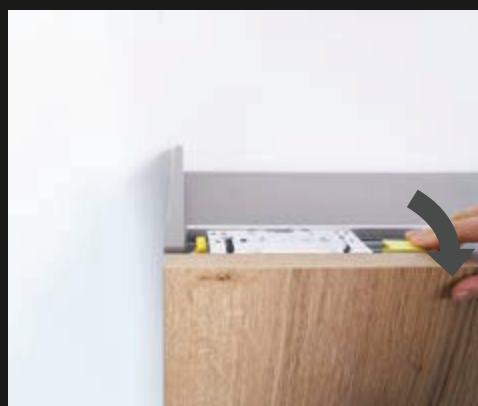
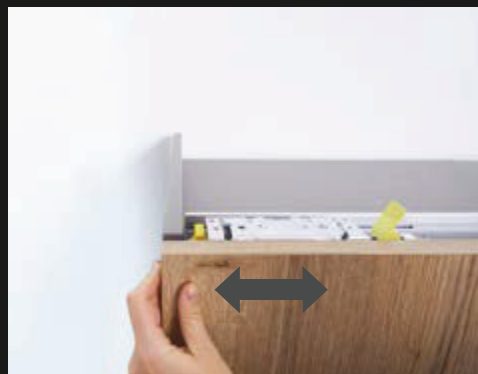

**Straightforward height adjustment:** the quickest way to adjust sliding doors is when they are closed. Door height is conveniently adjusted from the front and gap alignment can be checked straight away. Alternatively, ceiling height constructions are adjusted from the side.

**Perfect overlay adjustment:** adjust door overlay by any amount with the door closed - for instantly visible results. Without any tools whatsoever.

[www.hettich.com](http://www.hettich.com)

Order no.: 9.288.378  
1902-036\_TopLine-XL\_ArgFolder\_01/20\_HMV/en

The logo for INTERFER features the word "INTERFER" in a bold, black, sans-serif font. It is framed by a thick red horizontal bar above and a thick green horizontal bar below. A small black dot is positioned above the top-left corner of the red bar.

**INTERFER**

Technik für Möbel

The Hettich logo consists of the word "Hettich" in a bold, black, sans-serif font. Above the letters "t" and "i" are four parallel diagonal lines in blue, green, yellow, and red from top-left to bottom-right.

**Hettich**

# Sistema de porta de correr para posição de porta sobreposta

► TopLine XL / Sistema a correr no fundo superior do móvel



## Tecnologicamente avançado, visualmente discreto.

Do piso ao tecto, enormes portas deslizantes impressionam e enriquecem visualmente o espaço. O novo sistema de portas de correr TopLine XL da Hettich é a chave para a criação de mobiliário com design exclusivo. O sistema

estabelece novos padrões em termos de funcionamento, segurança e facilidade na montagem.

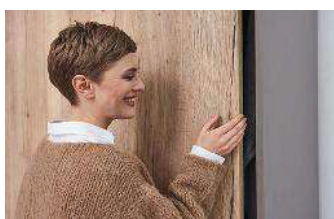

**Facilidade de utilização inspiradora:** Abertura fácil, fecho suave, ruído mínimo.



**Acabamento perfeito:** Fitas decorativas de colar em três cores acrescenta um toque final ao perfil superior.

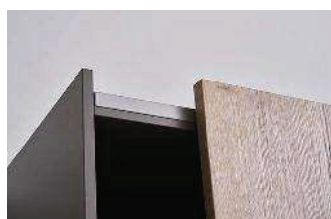

**Elegante montagem por cliques:** Armários do chão ao tecto sem parafusos visíveis.



**Conveniência prática:** A porta central abre-se intuitivamente para a direita e para a esquerda.



**Proteção inovadora para portas:** O sistema protege as portas do contato direto com o chão deslizando-as para cima, evitando possíveis danos.

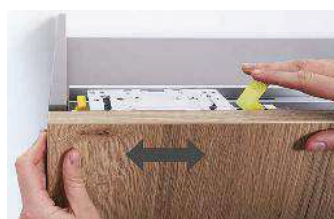

**Ajuste de sobreposição perfeito:** Ajuste sem ferramentas de portas fechadas com resultados imediatamente visíveis.



**Ajuste simples da altura:** De frente quando as portas estão fechadas ou de lado, se estiverem muito próximas do tecto.



[hettich.com/short/69f314](https://hettich.com/short/69f314)

**Saiba mais:** Pode obter inspiração e mais detalhes do produto no nosso site.

# Sistema de porta de correr para posição de porta sobreposta

- ▶ TopLine XL / Sistema a correr no fundo superior do móvel
- ▶ Resumo do desempenho

## Princípio do design

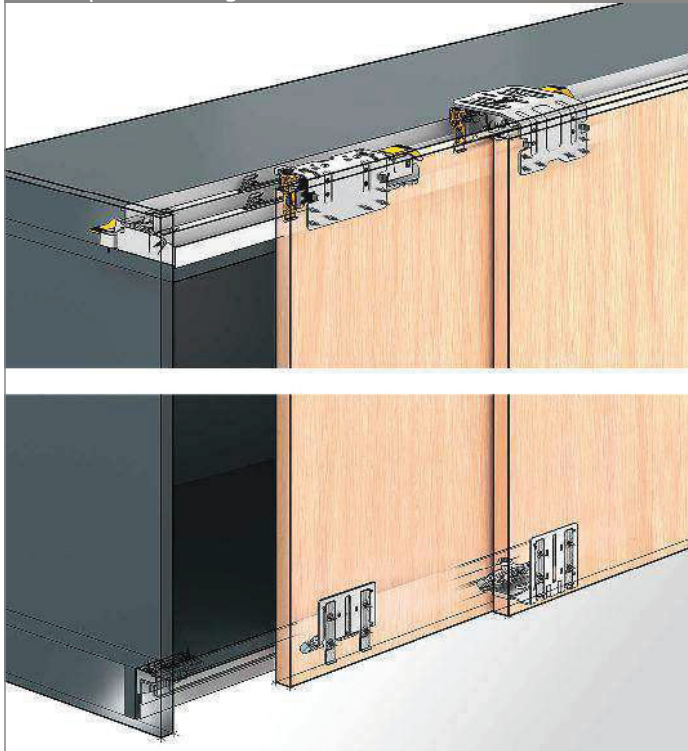

## Informações gerais

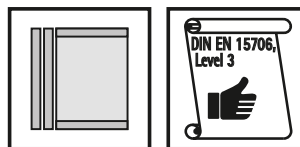

## Medidas da porta / peso da porta

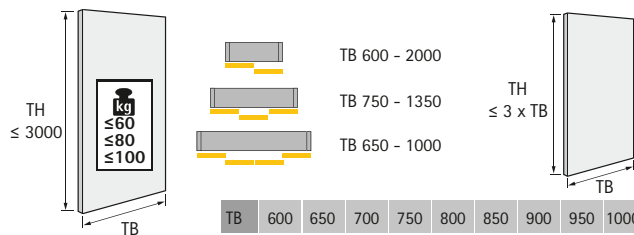

hettich.com/short/8681f2

## Número de portas e posição das portas

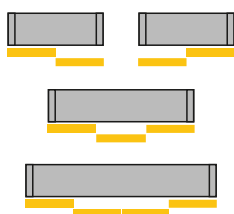

## Ajuste de altura/cobrimento

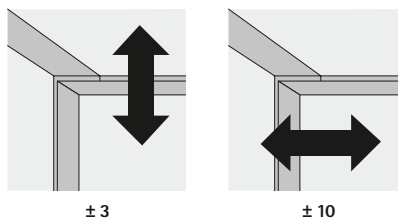

## Material da porta

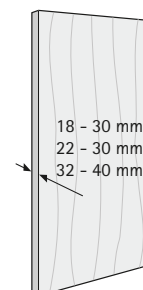

## Sistema Silent System

	2 portas	3 portas	4 portas
Fecho suave			
Amortecimento de abertura			

# Sistema de porta de correr para posição de porta sobreposta

- ▶ TopLine XL / Sistema a correr no fundo superior do móvel
- ▶ Medidas Técnicas para montagem - Sumário

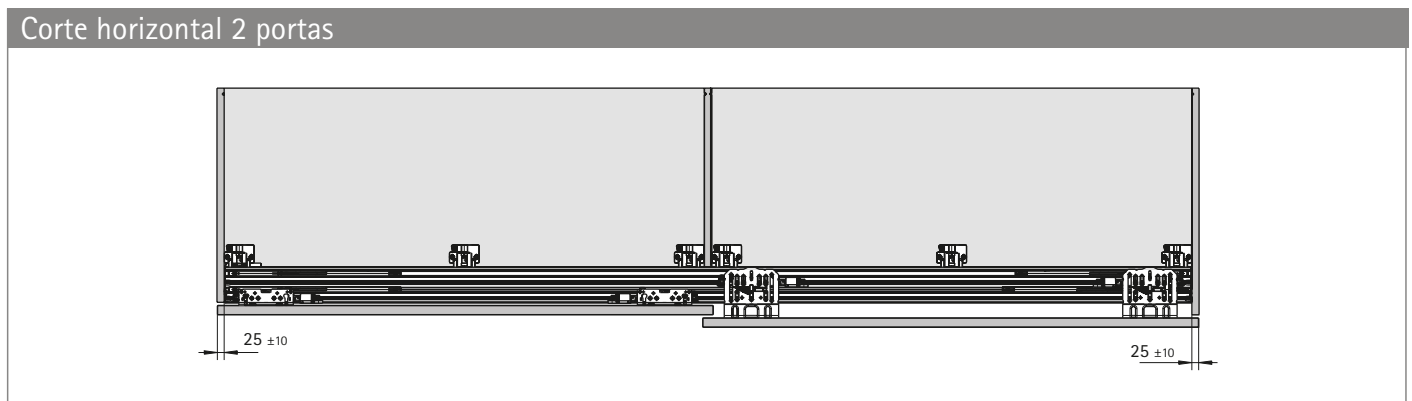
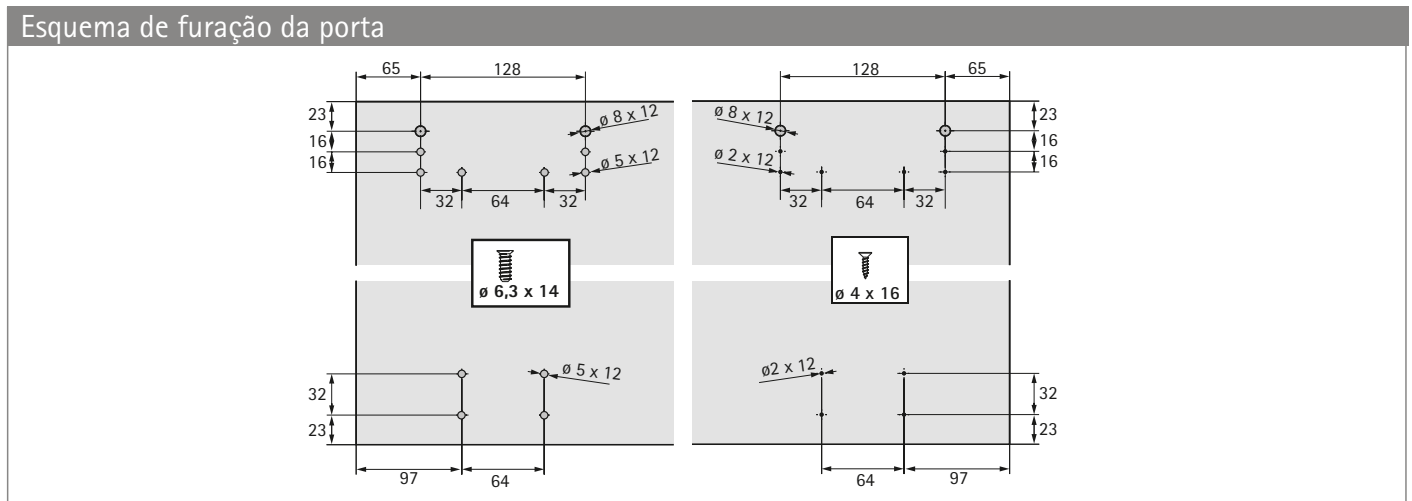
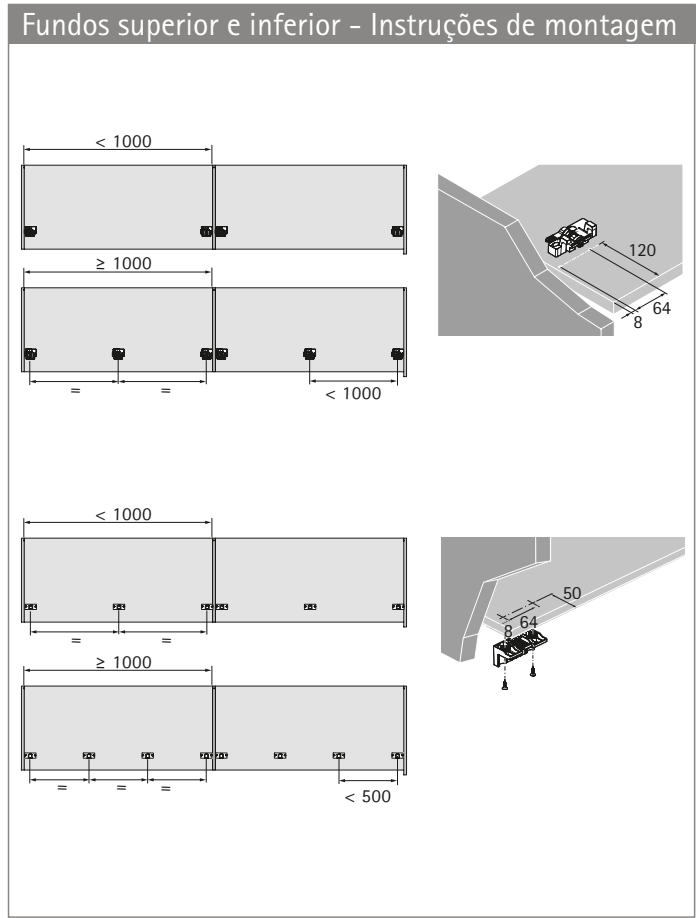
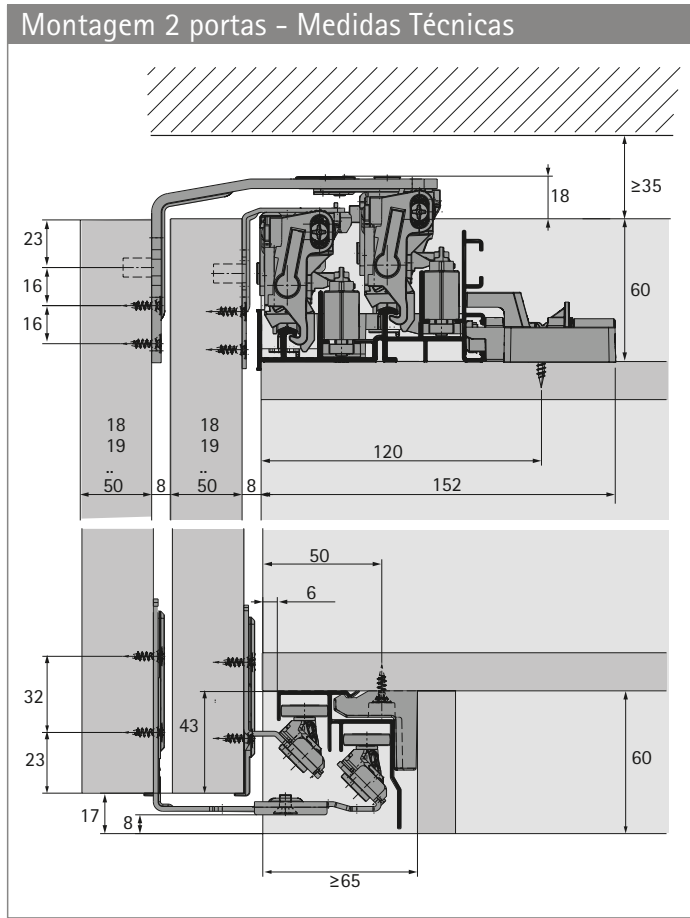



# Sistema de porta de correr para posição de porta sobreposta

- ▶ TopLine XL / Sistema a correr no fundo superior do móvel
- ▶ Componentes do sistema

## Componentes do sistema

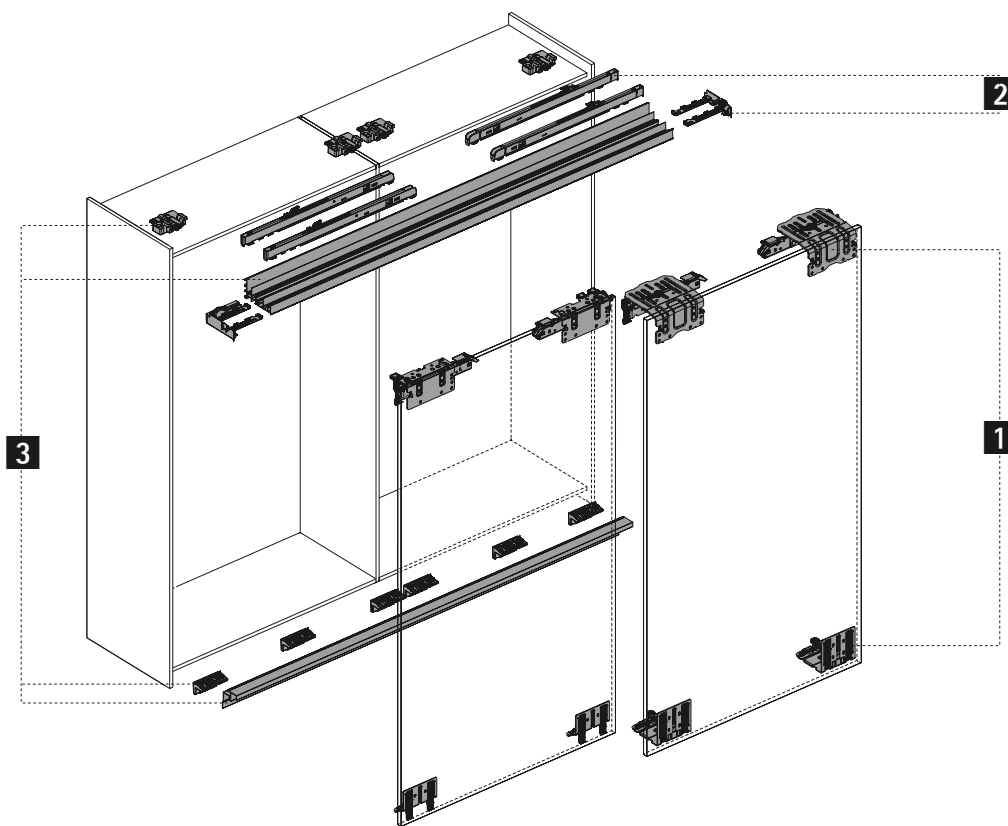

### 1 Componentes da guia e da calha de correr

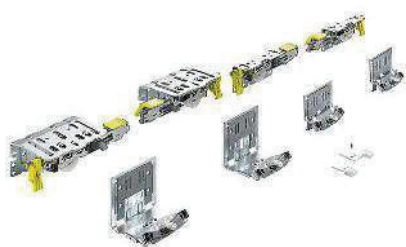

### 2 Sistema Silent System



### 3 Calha de correr e perfil da guia

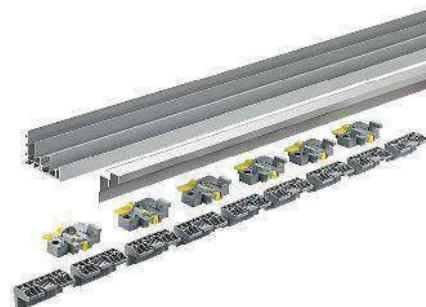

### 4 Acessórios do sistema



# Sistema de porta de correr para posição de porta sobreposta

- ▶ TopLine XL / Sistema a correr no fundo superior do móvel
- ▶ Componentes do sistema

## 1 Componentes da guia e da calha de correr

- ▶ Conjunto contém todos os componentes de correr e guia para armários e roupeiros de portas de correr de 2 / 3 / 4 portas

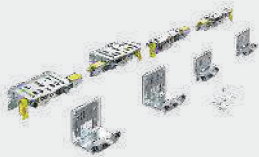
Imagem	Espessura máxima da porta mm	Peso máximo da porta kg	Código / Nr. de portas			Emb.
			2-portas	3-portas	4-portas	
	18 - 30	60	9 275 796	9 275 786	9 278 780	1 conj.
	22 - 30	80	9 275 794	9 275 785	9 278 791	1 conj.
	32 - 40	100	9 275 787	9 275 783	9 278 793	1 conj.

## 2 Amortecimento Silent System

- ▶ O conjunto contém elementos amortecedores de fecho e abertura, bem como tapas terminais.
- ▶ Conjunto de 3 portas inclui o Silent System da porta central para abrir a porta para a esquerda e direita
- ▶ Conjunto de 4 portas inclui componentes de sincronização para abertura simultânea das portas do meio

Imagem	Peso da porta kg	N.º de encomenda / número de portas			Emb.
		2-portas	3-portas	4-portas	
	15 - 35	9 276 735	9 276 645	9 278 798	1 conj.
	30 - 80	9 276 732	9 276 643	9 278 799	1 conj.
	60 - 100	9 276 737	9 276 646		1 conj.

## 3 Perfis de rolamento e perfis de guia

### Conjunto de perfis

- ▶ O conjunto contém um perfil de correr e um perfil guia cada um para montagem com cliques e cliques para fixação do perfil.
- ▶ Perfis de correr / guia: Alumínio anodizado prata

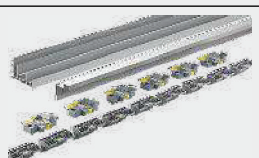
Imagem	Comprimento mm	Código	Emb.
	2300	9 278 672	1 conj.
	4000	9 278 657	1 conj.

### Indicações

- ▶ Acessórios para sistemas de portas de correr 799 - 809
- ▶ Sugestões de design 810 - 812



[hettich.com/short/185611](https://hettich.com/short/185611)

# Sistema de porta de correr para posição de porta sobreposta

- ▶ TopLine XL / Sistema a correr no fundo superior do móvel
- ▶ Componentes do sistema



## 4 Acessórios do sistema

### Tapa para o perfil

Imagem	Descrição	Código	Emb.
	<ul style="list-style-type: none"><li>▶ Para cobrir perfil na porta da frente</li><li>▶ Comprimento 2000 mm</li><li>▶ Pode ser cortada à medida.</li><li>▶ Plástico, cinzento, com acabamento pintável</li></ul>	9 278 801	1 conj.

### Cores decorativas

- ▶ Fita decorativa autocolante para fácil aplicação na superfície visível do perfil superior

Imagem	Cor	Comprimento mm	Código	Emb.
	Preto	2500	9 209 402	1 conj.
		4000	9 209 403	1 conj.
	branco	2500	9 209 404	1 conj.
		4000	9 209 405	1 conj.

### Sistema de desempenamento

Imagem	Descrição	Código	Emb.
	<ul style="list-style-type: none"><li>▶ Utilização recomendada como medida de precaução para evitar o empenamento de portas</li><li>▶ Deve ser utilizado pelo menos um conjunto de acessórios de ajuste por porta de correr.</li></ul>	9 252 651	1 conj.

### Indicações

- ▶ Acessórios para sistemas de portas de correr 799 - 809
- ▶ Sugestões de design 810 - 812



[hettich.com/short/185611](https://hettich.com/short/185611)